

# BC43

## The Ultimate Benchtop Confocal Microscope

### Key Features

- ✓ Benchtop multimodal imaging system
- ✓ Instant confocal: Blur-free imaging
- ✓ Widefield imaging
- ✓ Differential phase contrast & brightfield
- ✓ Borealis uniform illumination
- ✓ GPU-powered deconvolution

### Key Applications

- ✓ Cell biology
- ✓ Developmental biology
- ✓ Neuroscience
- ✓ Cancer biology
- ✓ Tissue imaging
- ✓ Organoids & large organisms



# Andor Benchtop Confocal

2D and 3D imaging as easy as ABC

**1** **Advanced imaging technology**  
Sharp 2D & 3D images instantly.



**2** **Enhanced visualisation software**  
Intuitive and powerful. Achieve outstanding results quickly with minimal training.

**3** **Easy to use**  
Ergonomic joystick and 2x objective allow quick sample overview.



**4** **Benchtop design**  
Light tight lid and inbuilt anti-vibration, so no need for a darkroom or optical table.

**5** **Optimal performance**  
Multidimensional experiments possible. Patented Focus Seek & Lock ensures accuracy in acquisition. Patented Borealis ensures uniform illumination for seamless stitching.

**6** **Flexible**  
Confocal, widefield and transmitted light imaging modes to suit your experiment.

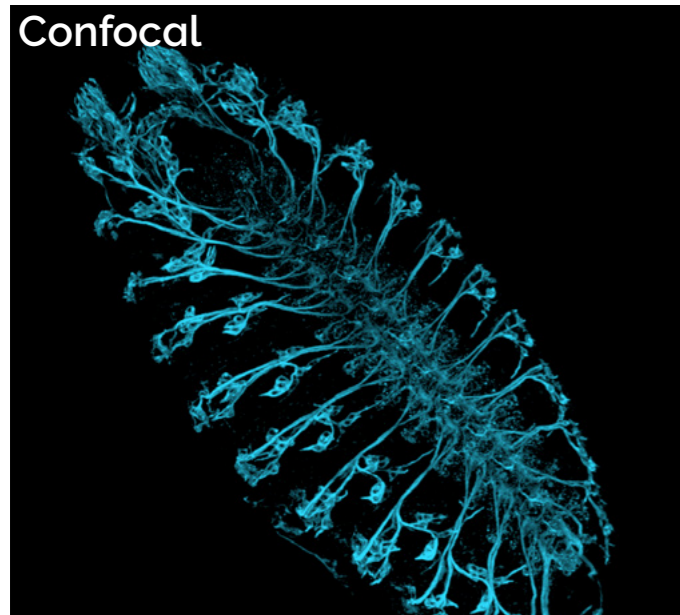

Confocal

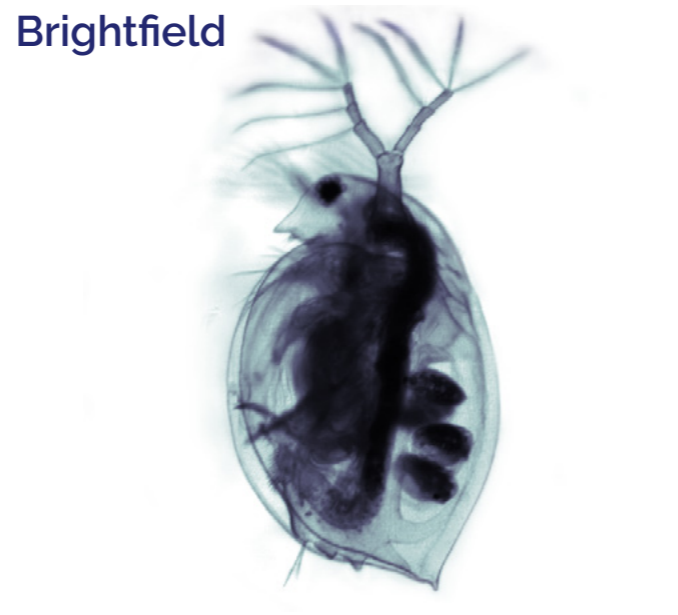

Brightfield

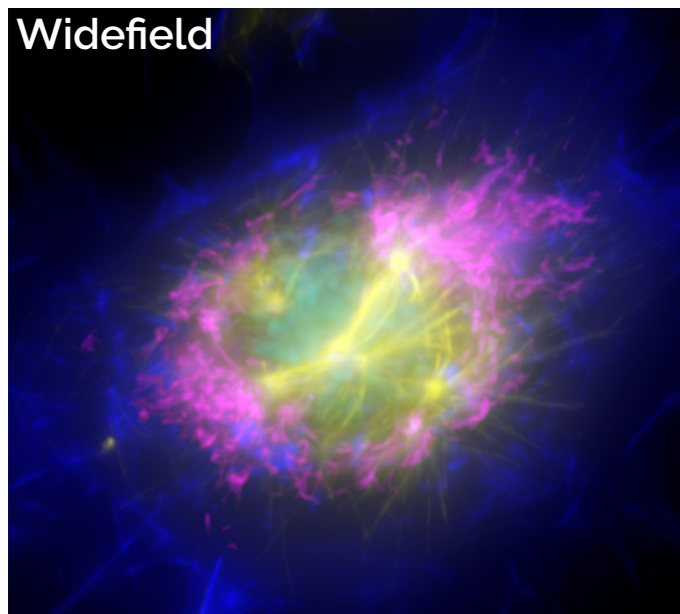

Widefield

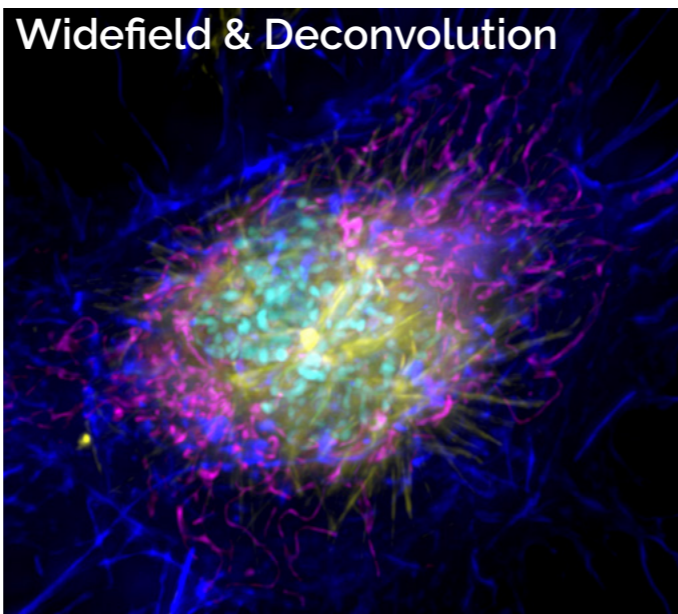

Widefield & Deconvolution

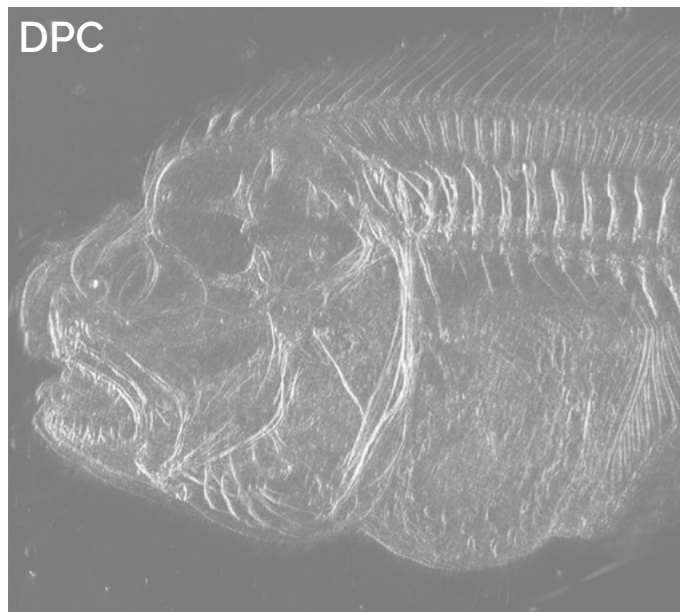

DPC

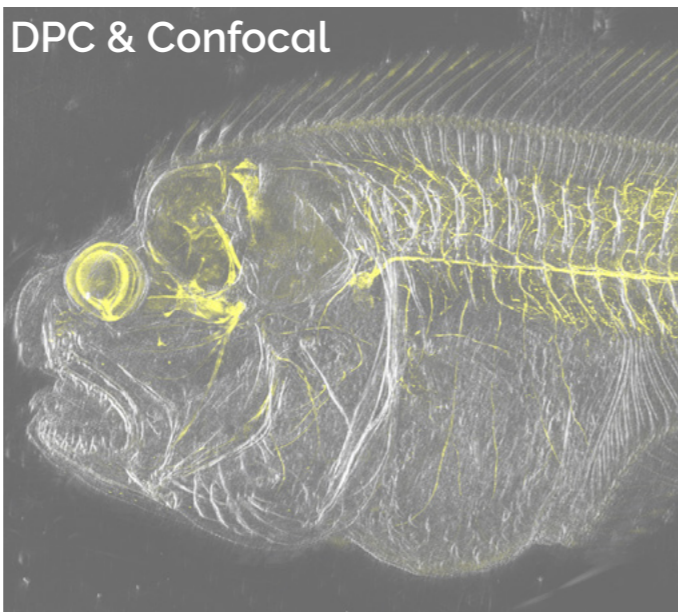

DPC & Confocal

# Andor Benchtop Confocal

## Total Imaging Flexibility

### ✓ Confocal Imaging

Confocal technology provides **high-contrast, blur-free images**. It boosts image quality of thin samples, such as monolayer cultures, and is especially suited for thick samples like small model organisms, 3D cultures and cleared tissues.

BC43 captures images at **least 10x faster than point scanning confocals**, boosting productivity, yet maintaining full resolution. Image deeper with higher quality than solutions that rely on computational clearing or deconvolution alone.

Until now confocal has been too expensive and complex for many. BC43 is revolutionary – a confocal at the heart of your lab at an **affordable price with no expertise required!**

### ✓ Widefield Imaging

With such easy access to confocal why use widefield imaging? Widefield is appropriate especially for thin samples, where it can provide greater **sensitivity and higher speeds, resulting in an increase in productivity and temporal resolution**. Combine with **deconvolution** for resolution comparable to a confocal image. Examples of suitable samples are tissue sections or micro-organisms.

### ✓ Transmitted Light Imaging

BC43 offers two transmitted light options: **Brightfield** for samples with inherent contrast like larger organisms, and **Differential Phase Contrast (DPC)**, that can be applied for samples which deliver high and low contrast.

You can even **combine image modes** for even greater imaging flexibility! For example, combine DPC with widefield or confocal imaging modalities.

# Application Focus

## Developmental Biology

BC43 cuts through the challenges easily, spanning development from the first rounds of cell division to the fully developed organism. Use BC43 to image at depth, in gentle live imaging experiments of cells and tissues. Effortlessly acquire multiple Z stacks, multiple tiles in combination with time-lapse imaging.

Extract sharp 2D images or instantly explore stunning 3D volumes in a fraction of the time you're used to.

BC43 delivers fast high-resolution imaging of developing model organisms (e.g. zebrafish and drosophila). Imaging deeper than conventional fluorescence microscopes and delivering a 10-fold more productive experience than a traditional confocal. No sacrificing sensitivity, resolution or 3D detail for speed, or to avoid bleaching.

BC43 features for development biology:

- ✓ Fast high resolution imaging.
- ✓ Image deep in both live and fixed samples.
- ✓ Montage & seamless stitching at any level of magnification.

*"I found BC43 super easy to setup for all my experiments and super fast to acquire and deliver high-quality data. I love its flexibility."*

*Marco Campinho,  
Group Leader CBMR- UAlg.*

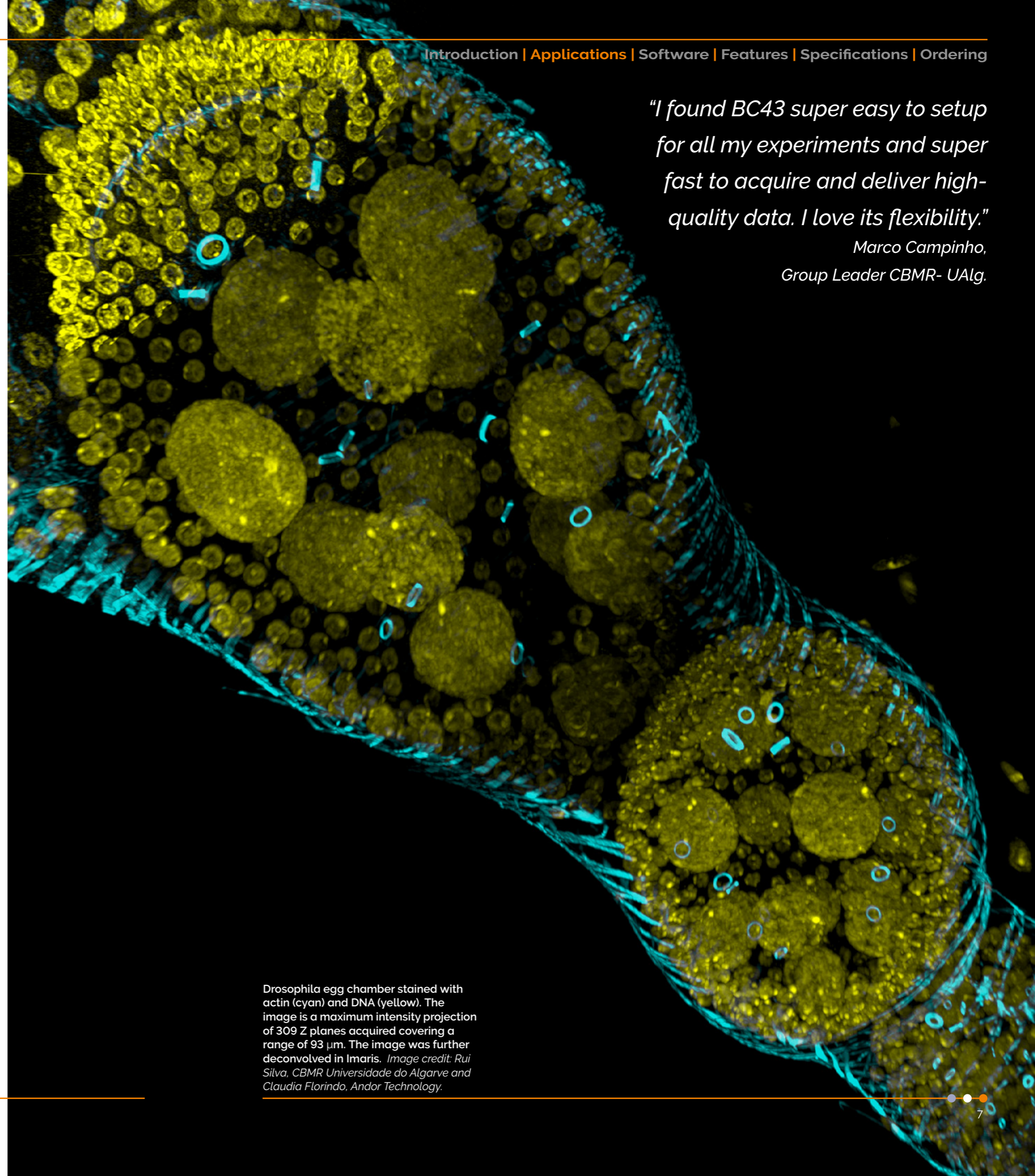

Drosophila egg chamber stained with actin (cyan) and DNA (yellow). The image is a maximum intensity projection of 309 Z planes acquired covering a range of 93  $\mu\text{m}$ . The image was further deconvolved in Imaris. Image credit: Rui Silva, CBMR Universidade do Algarve and Claudia Florindo, Andor Technology.

# Application Focus

## Cell Biology

Working closely with leading cell biologists we have carefully developed BC43 to meet the needs of a broad range of experiments. Reveal the detail inside cells from nm to mm within tissues and whole model organisms with BC43. Use BC43 in confocal mode to see detail hidden in the sample background or image in widefield to increase sensitivity and speed.

Image fast dynamic events, such as microtubule dynamics, or study longer processes like cell cycle over 24 hours with no photobleaching or phototoxicity.

BC43 features for cell biology:

- ✓ Image long processes.
- ✓ Image fast dynamic events.
- ✓ No photobleaching or phototoxicity.
- ✓ nm to mm imaging capability.

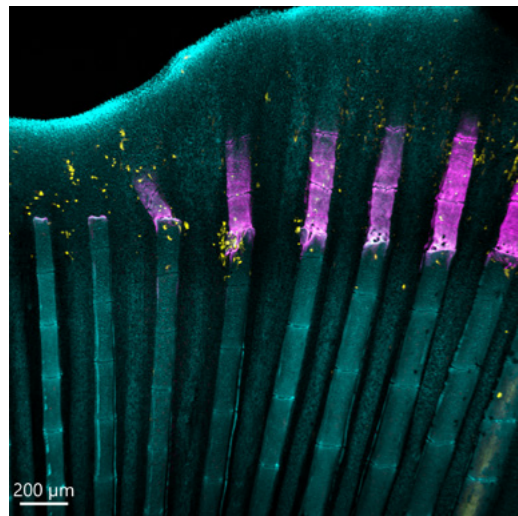

**Zebrafish fin in the process of bone regeneration.** Image shows the perfect stitching of 4 imaging fields, using three channels and 51 stacks for each field, covering a Z range of 174 μm. Newly formed bony tissue in purple (calcein staining) and cathepsin k+ cells (the osteoclasts) in yellow, DNA is in Cyan. *Image credits: Alessio Carletti, Universidade do Algarve.*

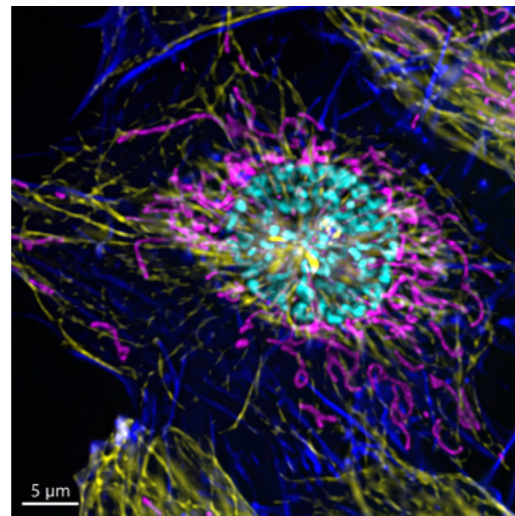

**Mammalian cell in prophase.** Image was acquired using BC43 confocal mode, using 4 acquisition channels and covering 10 μm Z range at Nyquist. Image was further deconvolved and rendered in Imaris. Dark blue - actin, yellow - microtubules, magenta - mitochondria, cyan-DNA. *Image credits: Claudia Florindo, Andor Technology.*

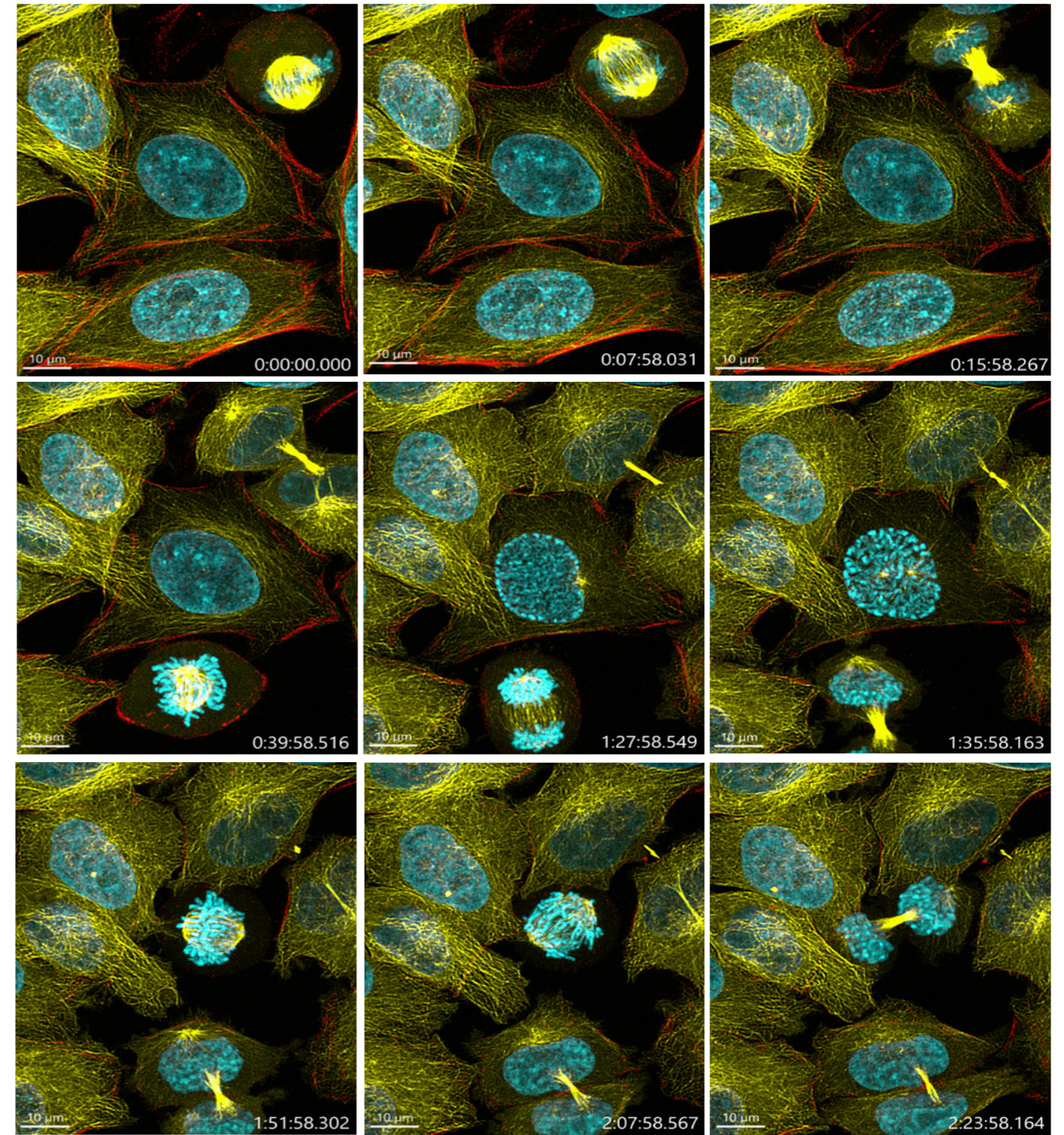

**Cell division.** Mammalian cells imaged with BC43 using confocal imaging mode for over 4 h. At each time point, 4 independent positions were imaged and for each position 3 channels and 15 Z stacks acquired. Images from one of the 4 positions. Cells undergoing mitosis during the course of the imaging. Red-actin, yellow-microtubules, DNA-cyan.

*Image credits: Ines Baião-Santos and Álvaro Tavares, Universidade do Algarve, Claudia Florindo, Andor Technology.*

# Application Focus

## Tissue Imaging

Large area imaging needs to provide both cellular resolution and the full organ context. The advanced high-speed technology in BC43 means you no longer need to compromise. Large area tissue confocal imaging is now possible. Ten times faster than regular confocals. No sacrifices in resolution, or field of view. BC43 delivers results **fast, shortening the time to publication.**

Discover more in intact tissues, use cleared samples and BC43 in confocal mode to image even thicker samples. BC43 takes advantage of the working distance of modern objectives: imaging hundreds of microns at high magnifications, and beyond.

BC43 features for tissue imaging:

- ✓ Fast confocal and low light widefield imaging.
- ✓ Seamless large tissue imaging for fixed and live sample.
- ✓ Image from nm to mm.

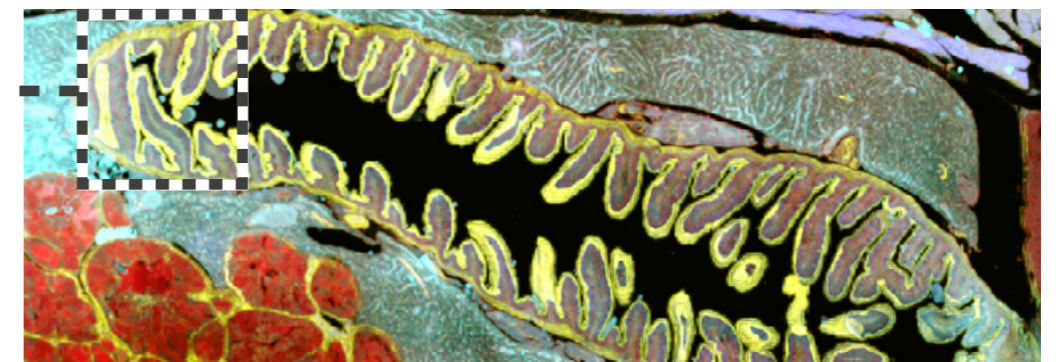

**Zebrafish intestine stitched image.** Image was acquired using the confocal imaging modality of BC43, with 4 imaging channels, 77 stacks and 28 tiles. The full stitched image is composed of a total of 15092 images. The deconvolution and stitching options were both activated on the protocol. Sample courtesy of Julien Resseguier, at NorMic, University of Oslo. *Image credits: Claudia Florindo, Andor Technology.*

# Application Focus

## Neuroscience

BC43 is the perfect workhorse for neuroscience. Imaging experiments commonly require high magnification, for resolution, imaging of large areas to fully understand the architecture and connectivity of this complex tissue. The incredible confocal capture rate of BC43 dramatically reduces imaging time delivering results faster.

BC43 features for neuroscience:

- ✓ Image both fixed and live samples,
- ✓ Deep into cleared brain sections.
- ✓ Developing organoids.
- ✓ Cover the breadth of neuroscience microscopy needs.

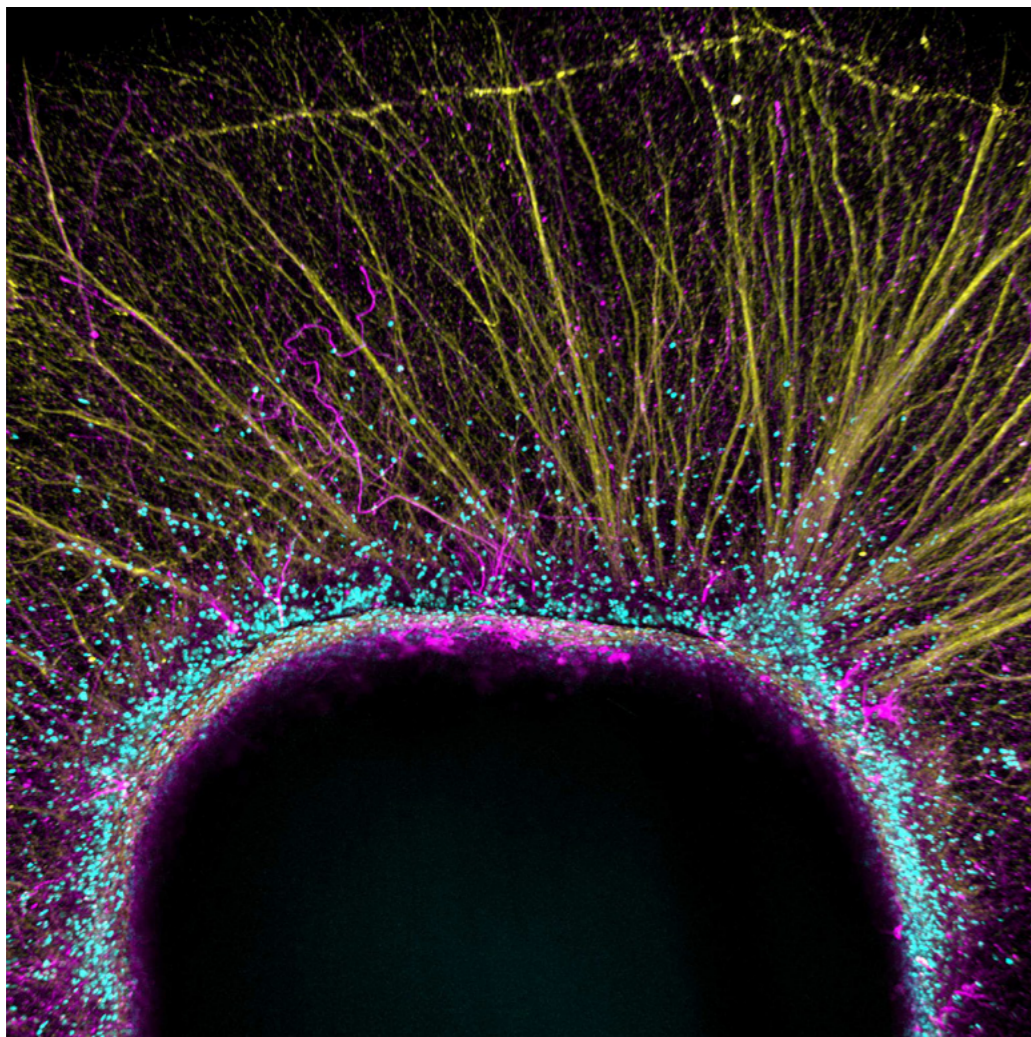

Mouse embryonic stem cell derived dopaminergic neurons cultured on top of a collagen hydrogel, expressing tyrosine hydroxylase (in magenta), GAP43 (in yellow) and DNA (in cyan). Image credit: Ana Marote from ICVS, University of Minho and Leonor Ribeiro from INL.

## Cancer

BC43 is a push-button confocal suitable for the broadest range of cancer experimental models. Capturing stunning images of:

- Subcellular events (e.g. cytoskeletal dynamics).
- Intercellular interactions,
- migration and division.
- 3D cultures from spheroids and organoids
- intact tissue and tumour models.

Use Imaris to analyse key parameters such as distribution of objects around a surface, volume overlap and nearest neighbour analysis.

Powerful machine learning classification, and batch mode can be used to deliver reproducible results in time saving workflows.

BC43 features for cancer studies:

- ✓ Image a wide range of cells and tissues.
- ✓ Analyse key parameters and indicators.
- ✓ Powerful tools for fast, reproducible results.

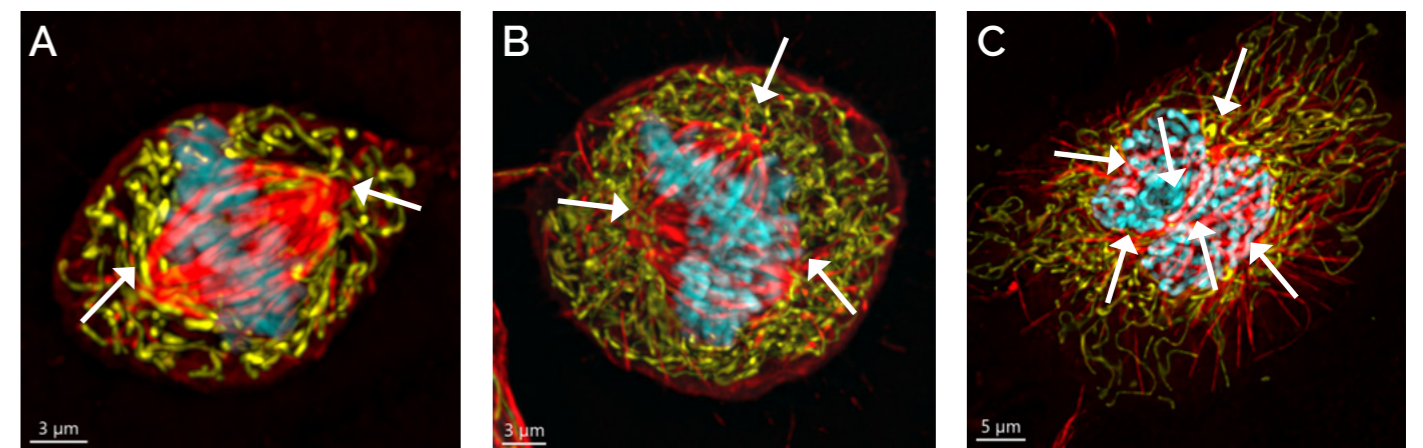

**Mammalian cells in division.** A) Normal cell division. B and C) Abnormal cell division. Cancer cells most often have abnormal cell division. In many cases, these cells do not have a bipolar mitotic spindle (as seen in A) but have multiple poles (as seen in B and C). These multiple poles can lead to abnormal separation of the genomic content, and the daughter cells will have multiple copies of certain genes and no copies of others. This is often named as "genome instability" which is a marker of cancer cells. Image credit: Claudia Florindo, Andor Technology.

# BC43 for Core Facilities

## Small in size, Big in performance

BC43 is an ideal instrument for a core facility, **easy to operate**, with **multiple microscopy techniques**. It provides great images fast, whatever the sample. Free up your more complex imaging systems for users doing highly specialised experiments.

Many imaging systems can be difficult for users to get comfortable using without extensive training. BC43 is intuitive and easy for even novice microscopists to master. Simple operating procedures, and minimal maintenance allow exceptional productivity from the system. This means **less time training, more time imaging and more time for core staff running the facility**.

BC43 features for core facilities:

- ✓ Low maintenance.
- ✓ Fast to learn, easy to use, minimal support.
- ✓ Application versatility.



**Whole-body flatfish at climax of development.** Fish was stained with acetylated tubulin (Yellow) and myosin heavy chain (blue). Image acquired with BC43 using multiple tile acquisition and montage. 30 tiles acquired to compose the image. Each tile had 175 slices, over a Z range of 521  $\mu\text{m}$ . *Image credits: Marco Campinho, CBMR Universidade do Algarve and Claudia Florindo, Andor Technology.*

# Integrated Software Solutions

## Fusion

BC43 has an integrated, easy-to-use, and accessible software interface that delivers high-end imaging. Users benefit from easy protocol set up for multidimensional experiments, such as one-click multi-position-montage and multiwell integration with an intuitive user interface and workflow for protocol set up.

BC43 Fusion delivers real-time GPU-based deconvolution increasing the resolution of the image. Seamlessly integrated into the hardware, the in-line 3D stitching allows the full montage and visualisation of multiple tiles integrated into the context of the whole organism.

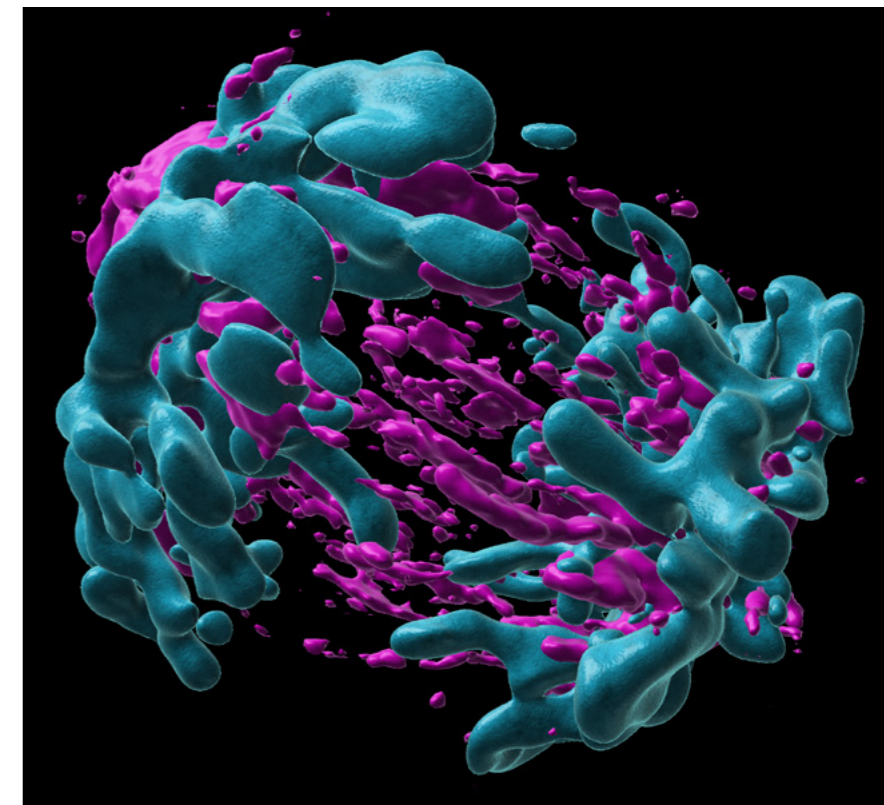

**Anaphase in mammalian cells.** Image shows a MIP of an anaphase cell. *Image credits: Álvaro Tavares, Ines Baião-Santos, CBMR Universidade do Algarve and Claudia Florindo, Andor Technology.*

## Imaris®

BC43 saves files in the Imaris IMS file format, permitting easy transfer of data into Imaris. Imaris for BC43 is included for isosurface rendering, high resolution snapshots, creation of multi-dimensional movies and downstream image editing. Additional application-specific modules of Imaris are available and include options for adding measurements suited for cell & developmental biologists, neuroscientists and many more disciplines within life sciences.

To find out more about Imaris please see: [imaris.oxinst.com](http://imaris.oxinst.com)



# Simple Workflows

Fast to learn & time saving

Here we show two possible workflows. All options can be performed in combination.

## Z Stack

Add Z stack for 3D image.

### Step 1

Select the area of sample to be imaged.

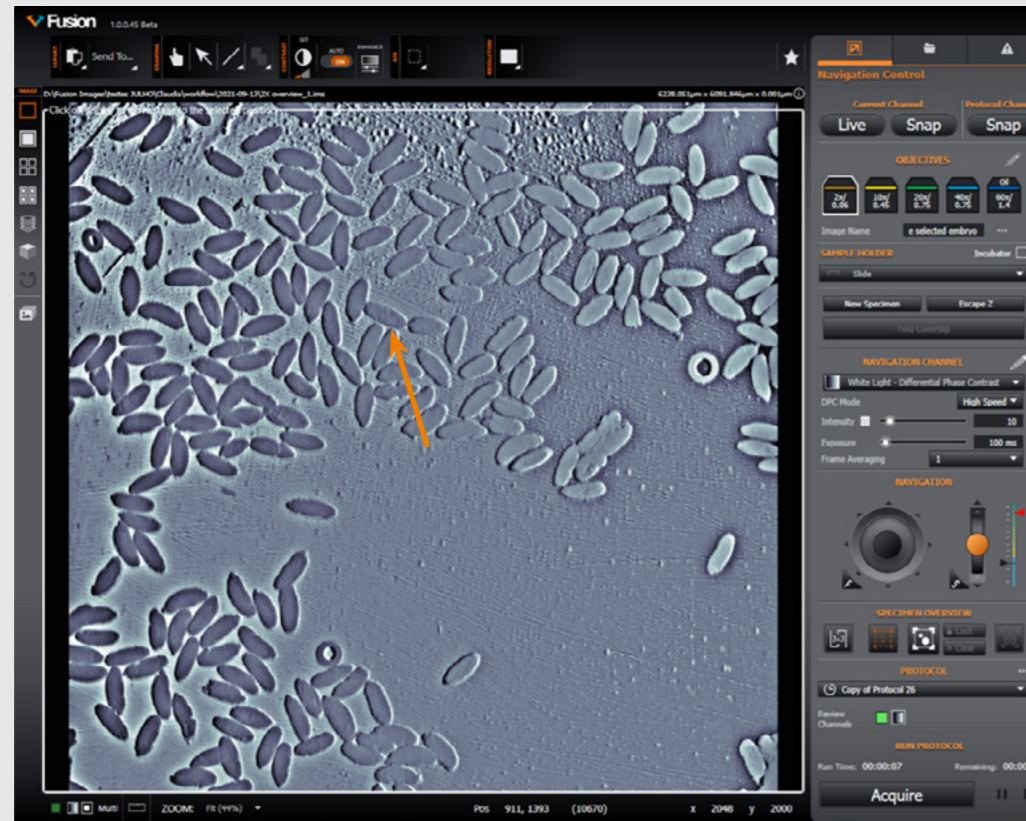

## Result

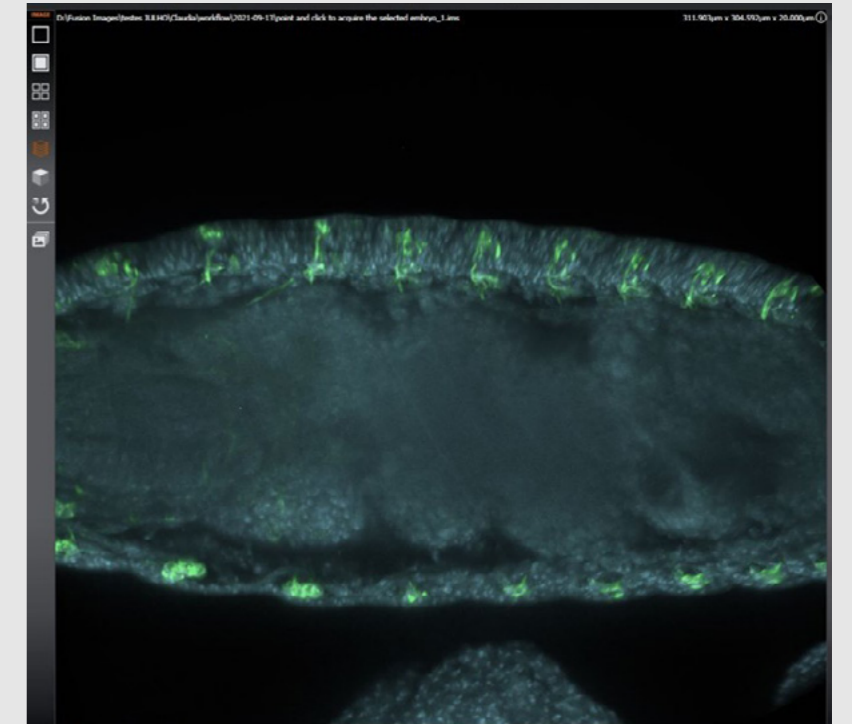

### Step 2

Select required objective.

Set centre of Z scan.

Press Acquire.

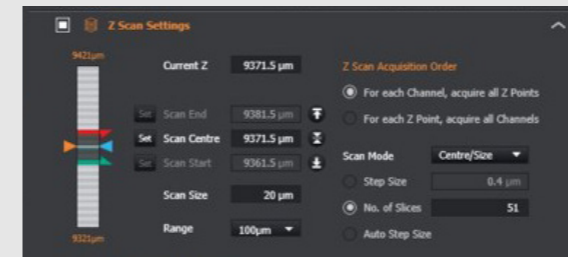

## Multi-position

### Step 1

Snap or overview the sample and move to the desired objective.

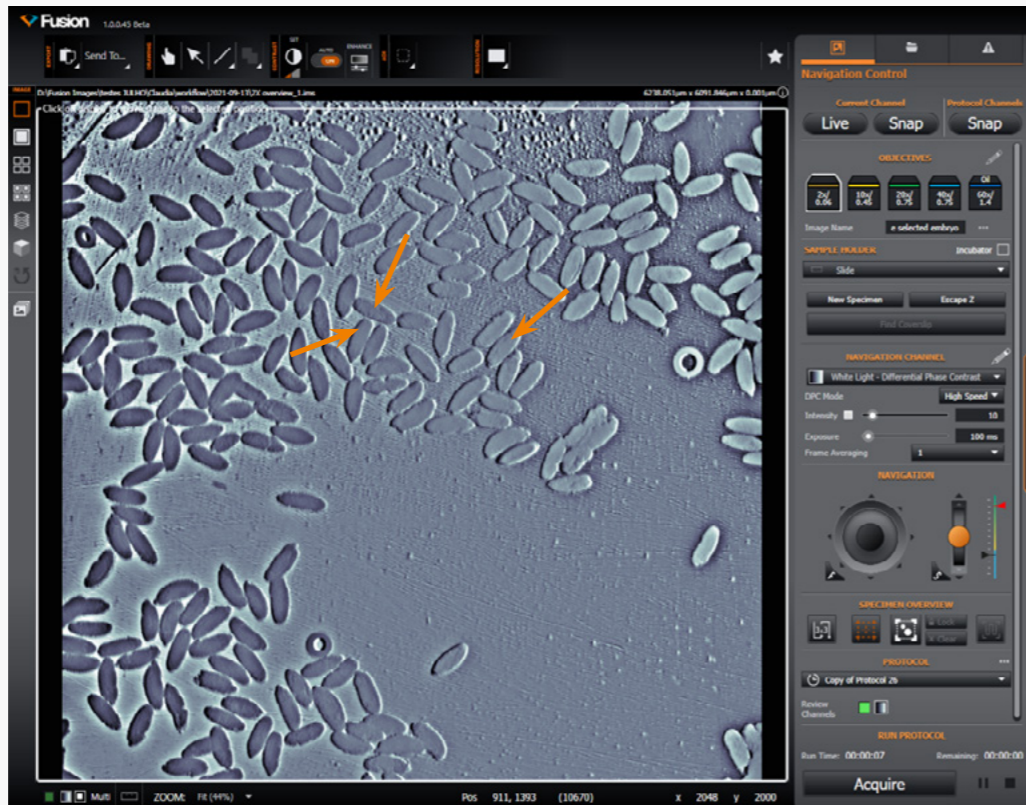

## Result

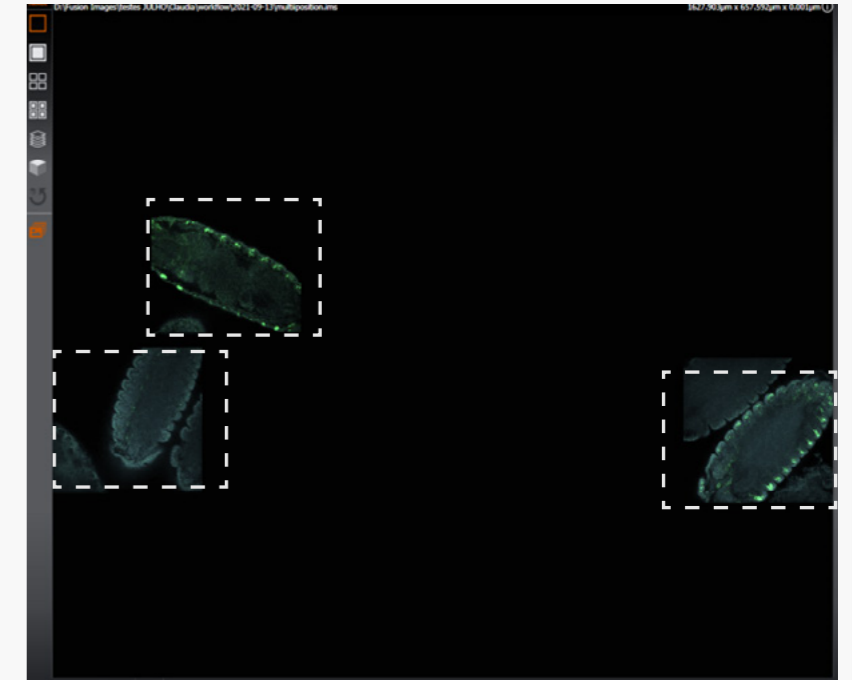

### Step 2

Select the positions to be imaged.

Press Acquire.

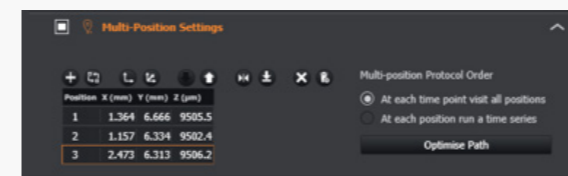

# Key Features of BC43

Hardware Feature	Benefit
<b>High-speed confocal imaging</b>	<ul style="list-style-type: none"> <li>✓ 3D optical sectioning with high background rejection. <b>Eliminates blur.</b></li> <li>✓ Allows <b>deep and large tissue imaging at speed</b> for higher productivity.</li> <li>✓ <b>Image fast dynamic events</b> in thicker samples.</li> </ul>
<b>Widefield imaging</b>	<ul style="list-style-type: none"> <li>✓ Image thin specimens/structures that do not require optical sectioning.</li> <li>✓ <b>Highest sensitivity</b> mode for samples <b>super-sensitive to light</b>, or to <b>detect the weakest fluorophores signals.</b></li> </ul>
<b>Benchtop system</b>	<ul style="list-style-type: none"> <li>✓ <b>No need for a dark room. Fits in a small bench space</b> in the laboratory.</li> <li>✓ Set up experiments and image immediately.</li> </ul>
<b>Built-in anti-vibration mechanism</b>	<ul style="list-style-type: none"> <li>✓ Ensures <b>optimal image quality</b> on your benchtop confocal when working at high-magnification and live-cell time-series.</li> </ul>
<b>2x objective for quick sample overview</b>	<ul style="list-style-type: none"> <li>✓ <b>Quickly navigate your sample</b> with an overview montage and select area to image.</li> </ul>
<b>3D ergonomic joystick</b>	<ul style="list-style-type: none"> <li>✓ <b>Efficient sample navigation</b>, position and focus with adjustable navigation and focus speeds.</li> </ul>
<b>Patented Borealis illumination</b>	<ul style="list-style-type: none"> <li>✓ Optimises illumination uniformity for <b>seamless stitching</b> and more accurate cross-field analysis.</li> </ul>
<b>Total imaging flexibility</b>	<ul style="list-style-type: none"> <li>✓ Image multiple fluorescent channels confocal and/or widefield.</li> <li>✓ <b>Capture multiple imaging modalities in one protocol</b>; fluorescence with brightfield and Differential Phase Contrast.</li> </ul>
<b>Differential phase contrast</b>	<ul style="list-style-type: none"> <li>✓ Capture <b>label-free images.</b></li> <li>✓ High contrast Andor transmitted light imaging modality.</li> </ul>
<b>sCMOS detector</b>	<ul style="list-style-type: none"> <li>✓ High sensitivity detector for short exposures and <b>reduced photobleaching.</b></li> <li>✓ <b>Maximise number of cells in a single image</b> and <b>capture large samples efficiently</b> with a large field of view e.g. image a 1.84 mm diagonal with 10x objective.</li> <li>✓ High dynamic range - <b>capture weak and bright signals in a single image</b> without saturation.</li> </ul>

Software Feature	Benefit
<b>Fusion for BC43</b>	<ul style="list-style-type: none"> <li>✓ Fast to learn and easy-to-use multidimensional acquisition software.</li> <li>✓ Integrated confocal, widefield and brightfield imaging options.</li> <li>✓ Post-acquisition processing with stitching and deconvolution.</li> </ul>
<b>Easy workflow</b>	<ul style="list-style-type: none"> <li>✓ From sample insertion to image acquisition. Add sample, find sample, set bounds, and acquire the image. <b>No expertise required.</b></li> <li>✓ <b>Quick montage</b> - Faster acquisition and experimental setup, <b>improve productivity.</b> Quick 3x3 sample overview, easy to set sample bounds, and center sample for image acquisition with one-click.</li> </ul>
<b>Patented Focus Seek &amp; Lock</b>	<ul style="list-style-type: none"> <li>✓ Focus Seek - makes <b>focusing on your sample easier.</b></li> <li>✓ Focus Lock - <b>maintains sample focus</b> during long time-lapse and large sample acquisitions.</li> </ul>
<b>Multidimensional acquisition</b>	<ul style="list-style-type: none"> <li>✓ Acquire multiple imaging dimensions to visualise all the sample features—simultaneous acquisition of time, Z and tile positions.</li> </ul>
<b>Multiposition</b>	<ul style="list-style-type: none"> <li>✓ <b>Acquire multiple positions</b> in a sample and <b>maximise throughput</b> from a single experiment.</li> <li>✓ <b>Multiposition montage</b> - Acquire multiple montages at independent positions and maximise throughput on fixed or live cell experiments.</li> </ul>
<b>Montage &amp; Stitching</b>	<ul style="list-style-type: none"> <li>✓ Automatically <b>capture large sample data</b> bigger than the field of view.</li> <li>✓ <b>Stitch huge sample montages</b> in 2D and 3D <b>for the full picture.</b></li> </ul>
<b>Multiwell</b>	<ul style="list-style-type: none"> <li>✓ Allow multiwell imaging for 6, 12, 24, and 96 well plates—image different treatment, phenotypes, drug screening experiments, etc.</li> </ul>
<b>Real-time 3D-rendering</b>	<ul style="list-style-type: none"> <li>✓ Immediate visual feedback on experimental progress to evaluate data and make appropriate decisions in real-time.</li> </ul>
<b>Clearview-GPU™ accelerated deconvolution</b>	<ul style="list-style-type: none"> <li>✓ <b>Increase image resolution</b> and contrast with deconvolution.</li> <li>✓ Up to 50x faster processing than non-GPU based deconvolution solutions.</li> </ul>
<b>Imaris for BC43</b>	<ul style="list-style-type: none"> <li>✓ Visualise your 2D/3D/4D images in the world's leading interactive microscopy image analysis software.</li> <li>✓ Generate isosurface reconstructions for better interpretation and presentation of raw images.</li> <li>✓ Create high resolution snapshots and multi-dimensional movies with ease.</li> </ul>

# Specifications<sup>1</sup>

Microscope Unit BC43	
Imaging Modes	High-speed confocal Widefield epifluorescence Transmitted light - brightfield and Differential Phase Contrast
Imaging Methods	Single colour, multicolour, z-stacking (volume), time-lapse, multi-position, multi-well, montage and 2/3D stitching.
ClearView™ GPU	Clears image of non-specific sample background signal and improves resolution beyond the normal optical limits.
Camera	
Resolution	6.5 µm pixel; 2048x2000 pixels (4.1 MP)
QE <sup>2</sup>	Up to 82%
Field of view (mm)	18.4 mm (diagonal)
Cooling	0°C
Images	16-bit, monochrome
Illumination	
Fluorescence	4 fixed wavelengths of 405 nm, 488 nm, 561 nm, 638 nm
Transmitted light	Broad spectrum visible light LED
Optics (Objectives)	
Objective Lens Nosepiece	Motorised 5 position turret
Objective Magnifications	BC43 is supplied with 2x objective for sample overview. Select additional supported objective lenses from 10x to 100x magnification.
Precision motorised x,y stage	Travel Range = 110 mm x 80 mm Resolution = 100 nm
Z-Control & Focus	Range = 14.5 mm
Autofocus "Seek & Lock" Technology	Sample "Seek & Lock". Finds focal plane for new sample and maintains focus stability during time-lapse experiments.*3
Sample Vessels Supported	Glass slides (25 by 75 mm); culture dish (35 mm diameter); Multiwell plates (6, 12, 24 & 96); Multiwell chamber coverslip (2, 4, 8). Optimal imaging through glass, for imaging through plastic vessels, consult your sales representative.
Incubation (option)	Stage-top incubator. Sliding lid for easy sample access and exchange. Objective heater for oil-immersion objectives.
Workstation	
PC	Windows™ 10 software 64 GB DDR4 RAM 512 GB PCIe SSD Boot drive 8 GB Graphics Card 2 TB Image data storage (option to add more) Windows™ 10 operating system Fusion control and BC43 edition of Imaris software**
Monitor	24 inch

# Mechanical Drawings

Units: Millimeters [Inches]

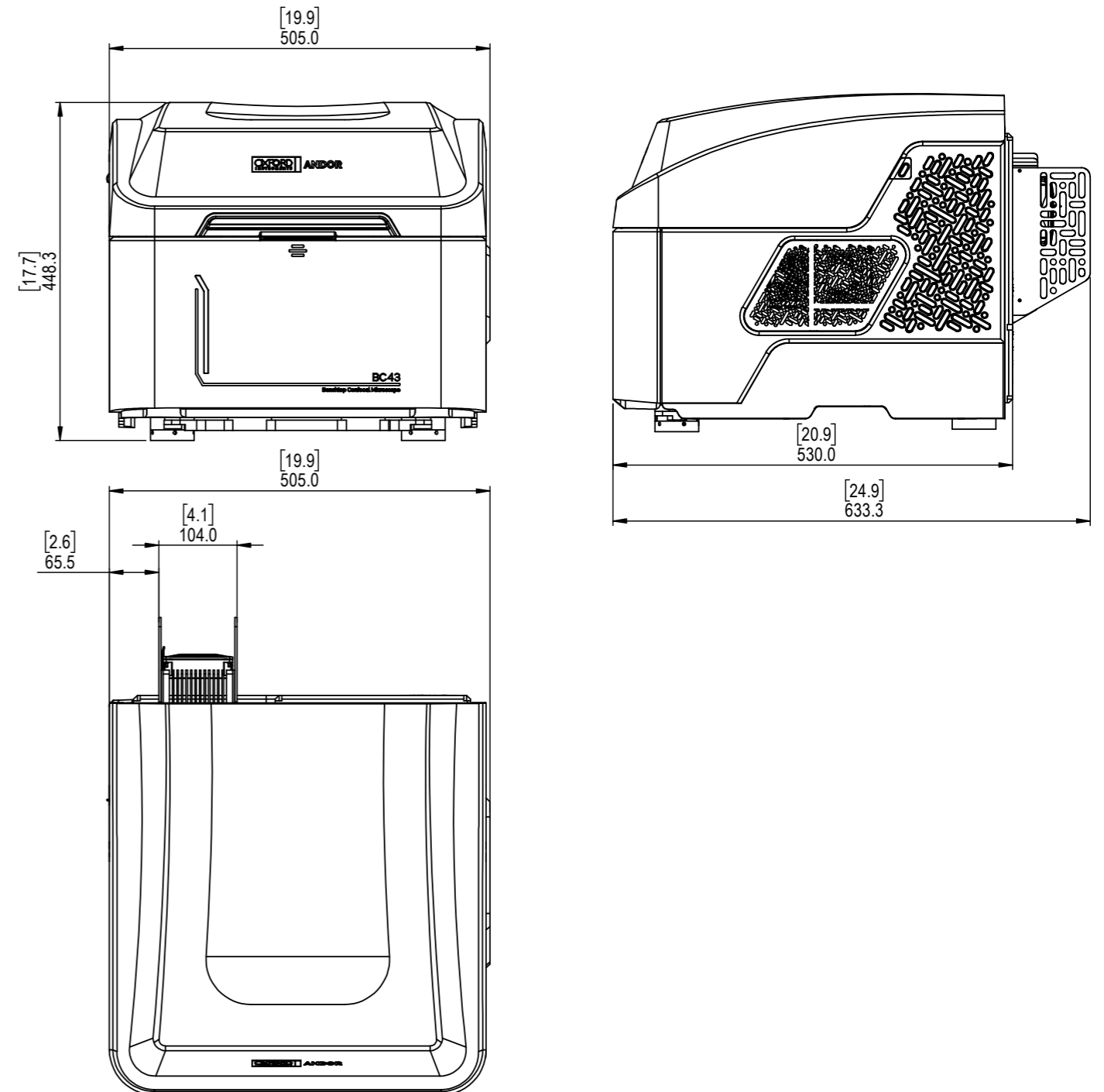

# Creating the Optimum Product for you

Please contact your local sales representative who will be able to guide you through the ordering process.

## Step 1. Choose the model

	Description	Order Code
 <p><b>BC43 Unit</b></p>	<p>Andor BC43 Benchtop Confocal Microscope. Equipped with:</p> <ul style="list-style-type: none"> <li>Brightfield and Differential Phase Contrast transmitted white light illumination for label-free visualisation and imaging, widefield epifluorescence for low-light imaging and microlens based spinning disk confocal for fast high-contrast high-quality 3D imaging.</li> <li>Built-in vibration management to support use on a regular laboratory bench or sturdy table.</li> <li>Patented Focus Seek and Lock to aid sample focus and to retain focus during time-lapse experiments.</li> <li>2x objective included to aid sample navigation. 4 additional positions available on the motorized turret to add objectives appropriate to your needs. Support up to 100x (choose from list of supported objectives).</li> <li>Excitation lines 405 nm, 488 nm, 561 nm &amp; 638 nm, and emission filter for imaging commonly used fluorophores such as DAPI, Alexa 488/GFP, Alexa 546/mCherry/TRITC, CY5/Alexa Fluor 640.</li> <li>Motorised x,y and z axis sample positioning via joystick or software interface.</li> <li>4.1 MP (6.5 µm pixel, 16-bit) monochrome camera with up to 82% QE, 18.4 mm diagonal field of view.</li> <li>Control software to capture multi-dimensional experiments in x,y,z, time, multi-position, multi-well and montage capture with 2/3D stitching. Includes ClearView GPU™ for super-resolution images with reduced sample background for optimal quality imaging.</li> <li>Workstation includes Motherboard: 8 Core, 12 M cache, base 3.6 GHz, up to 4.8 GHz, DDR4-2666, 64 GB RAM, 512 GB PCIe NVMe Class 40 M.2 SSD Boot drive, 4 GB Graphics Card, 2 TB image data storage, Windows 10 operating system.</li> <li>Imaris for BC43, downstream image editing, isosurface rendering, high resolution snapshots and creation of multi-dimensional movies.**</li> </ul>	INS-BTCF

## Step 2. Choose Software Setup

	Description	Order Code
Imaris Image Analysis Software	Imaris Quantify Package Imaris is installed on a separate offline PC for image analysis. NOT node locked to the acquisition workstation. Imaris Viewer will be installed with the BC43 workstation.	IMARIS-QUANT-SEP
	Imaris Quantify Package and add-on, if purchased, is installed on the BC43 workstation. Node-locked to the acquisition workstation.	IMARIS-QUANT-ACQ

## Step 3. Workstation upgrade options

	Description	Order Code
 <p>Options</p>	Data storage upgrade for supplied PC workstation. Up to two additional 4 TB drives can be added.	INS-PC-DRV-4TB

## Step 4. Select up to 4 supported objective lenses

	Description	Order Code
 <p>Objectives</p>	10x Plan Fluorite objective with 0.3 NA. Working distance of 16 mm.	INS-OBJ-10-030
	10x Plan Apochromat objective with 0.45 NA. Working distance of 4 mm.	INS-OBJ-10D-045
	20x Plan Apochromat objective with 0.8 NA. Working distance of 0.8 mm.	INS-OBJ-20D-080
	20x SPlan Fluor objective with 0.7 NA. Working distance of 2.3 mm.	INS-OBJ-20-070-LWD
	40x Plan Fluorite Objective with 0.75 NA. Working distance of 0.66 mm.	INS-OBJ-40-075
	40x Plan Apochromat objective with 0.95 NA. Working distance of 0.21 mm.	INS-OBJ-40D-095
	40x Plan Apochromat silicon oil objective with 1.25 NA. Working distance of 0.3 mm.	INS-OBJ-40S-125-SIL
	40x Plan Fluorite oil immersion objective with 1.3 NA. Working distance of 0.24 mm.	INS-OBJ-40-130-O
	60x Plan Apochromat oil immersion objective with 1.42 NA. Working distance of 0.15 mm.	INS-OBJ-60D-142-O
100x Plan Apochromat oil immersion objective with 1.45 NA. Working distance of 0.13 mm.	INS-OBJ-100D-145-O	

## Step 5. Select the required incubator

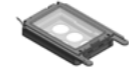
	Description	Order Code
 <p>Incubators</p>	Stage-top incubator with humidity module and digitally controlled CO <sub>2</sub> regulation using a pure CO <sub>2</sub> source	INS-INC-HUM-CO2-D
	Stage-top incubator with humidity module and manual valve controlled CO <sub>2</sub> regulation using a pure CO <sub>2</sub> source	INS-INC-HUM-CO2-M
	Stage-top incubator with humidity module and manual valve controlled CO <sub>2</sub> regulation using a pre-mix air/CO <sub>2</sub> cylinder	INS-INC-HUM-PRE-M

## Step 6a. Select the required incubator sample holders

	Description	Order Code
 <p>Incubator Sample Holders</p>	One position. 1x3 inch chamber slide holder	MSD-INCB-1XGS-M
	One position. 35 mm Petri-dish holder	MSD-INCB-1X35-M
	Two position. 35 mm Petri-dish holder	MSD-INCB-2X35-M
	One position. 1x3 inch chamber slide and #2 35 mm Petri-dish holder	MSD-INCB-GS35-M
	Open frame for multi well plates, suitable for oil immersion objectives	MSD-INCB-MW-OIL
	Two position. 1x3 inch chamber slide holder	MSD-INCB-2XGS-M
	One position. Lab-Tek 1x2 inch chambered cover glass holder	MSD-INCB-1XLBTK-M
	Two position. Lab-Tek 1x2 inch chambered cover glass holder	MSD-INCB-2XLBTK-IIM
	#1 Lab-Tek II 1x 2 inch chambered cover glass and #1 50/60 mm Petri-dish holder	MSD-INCB-LBTK-II-60M
	#2 Lab-Tek 1x2 inch chambered cover glass holder	MSD-INCB-2XLBTK-M
#1 Lab-Tek II 1x2 inch chambered cover glass holder	MSD-INCB-1XLBTK-IIM	

## Step 6b. Select the required incubator accessories

	Description	Order Code
 <p>Incubator Accessories</p>	Magnetic holder for 35 mm petri dish.	MSD-INCB-35-TL-M
	Lid with thermocouple for local / sample temperature recording at the level of the sample.	MSD-INCB-SENSOR

# Order Today

Need more information? At Andor we are committed to finding the correct solution for you. With a dedicated team of technical advisors, we are able to offer you one-to-one guidance and technical support on all Andor products.

For a full listing of our local sales offices, please see: [andor.oxinst.com/contact](http://andor.oxinst.com/contact)

Our regional headquarters are:

## Europe

Belfast, Northern Ireland  
Phone +44 (28) 9023 7126  
Fax +44 (28) 9031 0792

## Japan

Tokyo  
Phone +81 (3) 6732 8968  
Fax +81 (3) 6732 8939

## North America

Concord, MA, USA  
Phone +1 (860) 290 9211  
Fax +1 (860) 290 9566

## China

Beijing  
Phone +86 (10) 5884 7900  
Fax +86 (10) 5884 7901

### Items shipped with BC43

Base unit, cables and accessories (model as ordered)  
PC Workstation and accessories  
Fusion and Imaris for BC43 software  
User guides in electronic format  
Quick start guide  
Up to 5 microscope objectives  
3D navigation joystick  
Microscope slides

### Operating & Storage Conditions:

- Indoor use only
- Operating Temperature: 18°C to +25°C ambient
- Storage Temperature: 0°C to 50°C
- Relative Humidity: <70% (non-condensing)
- Size/Weight (BC43)  
W x D x H: 505 x 633 x 443 mm and 65 kg

### Power Requirements:

- Mains Supply: 100 - 240 VAC, 50 - 60 Hz.
- System Power Consumption (Typ./ Max.):  
75 W/ 90 W

**Cover Image:** FluoTissue mouse intestine section. Blood vessels labelled with AlexaFluor(R) 488 and Lymphatic vessels with AlexaFluor(R) 633. Image captured at 10x magnification with a 4x4 montage and stitched within Fusion. Imaged to a depth of 467 µm with a 1.99 µm step (total 235 optical sections). Sample sourced from SUNJin Lab.

*Image credits: Geraint Wilde, Andor Technology.*

### Footnotes

1. Figures are typical unless otherwise stated.
2. Quantum efficiency as supplied by the sensor manufacturer.
3. The Find Coverslip feature is not compatible with the 2x and oil immersion objective lenses. The Focus Stabilization feature cannot be used with the 2x objective lens.
4. Imaris for BC43 supplied, additional modules will require a separate license.

### Laser Safety Information

1. It is very hard to access the laser beam with the eye without using a reflective surface to redirect it.
2. Class 2 means that the eye aversion response protects against the laser radiation and you have to deliberately stare at it to cause damage. A typical Class 2 product is a laser pointer.

